

Front view

Side view

Inside enclosure view

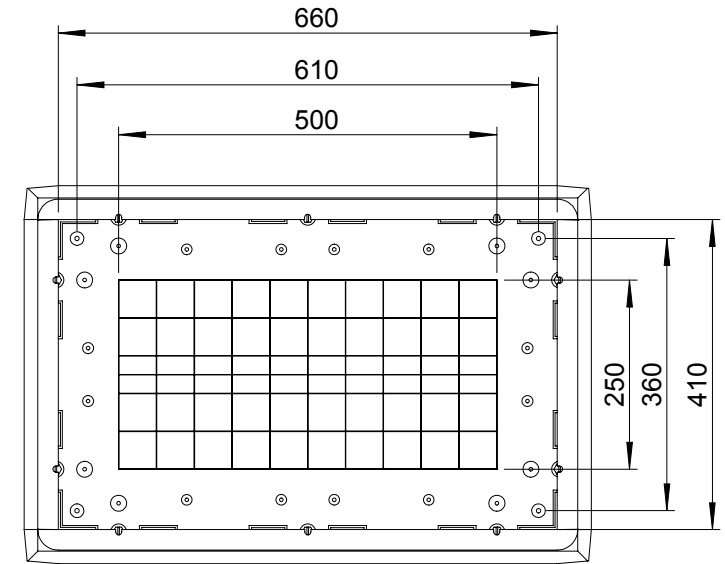
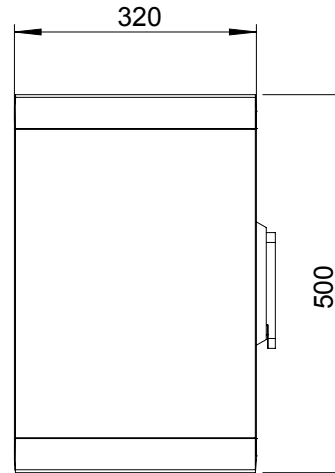
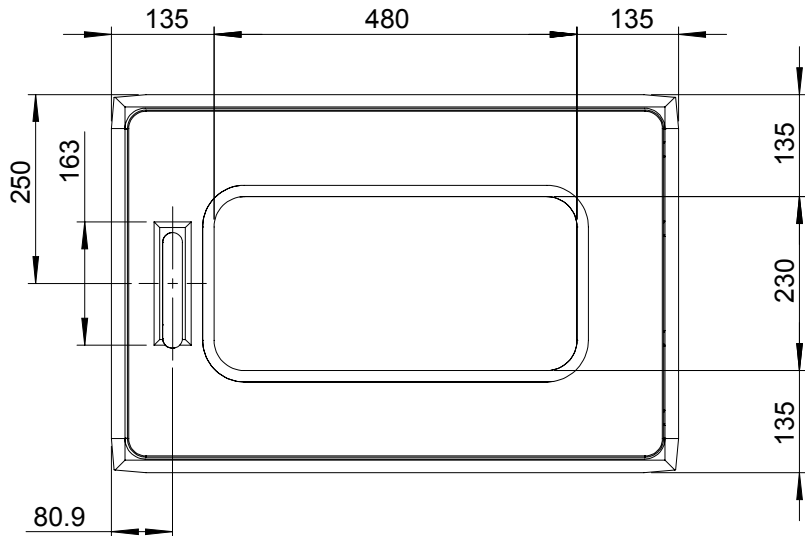

Top view

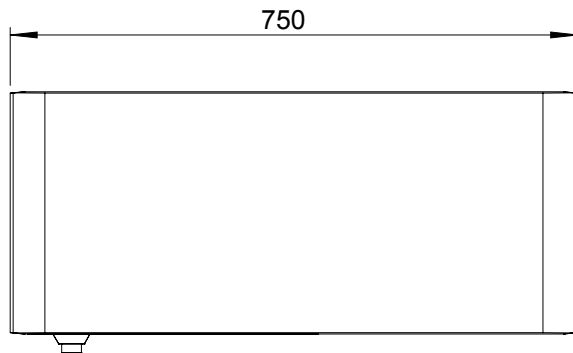

Drawn by : bvgрма	Date: 19-01-2015	Finish: RAL 7035	SCALE:1:10	General tolerances according to Norm ISO 2768-1		
Checked by : mderpu	Date: 19-01-2015					
Revision : 01				Fine	Medium	Coarse
		Fiber-glass reinforced polyester Enclosure, Modular version, Transparent door		Reference number : UDPT5075		A4
		500 mm x 750 mm x 320 mm				
						Page 1/1