

Front view

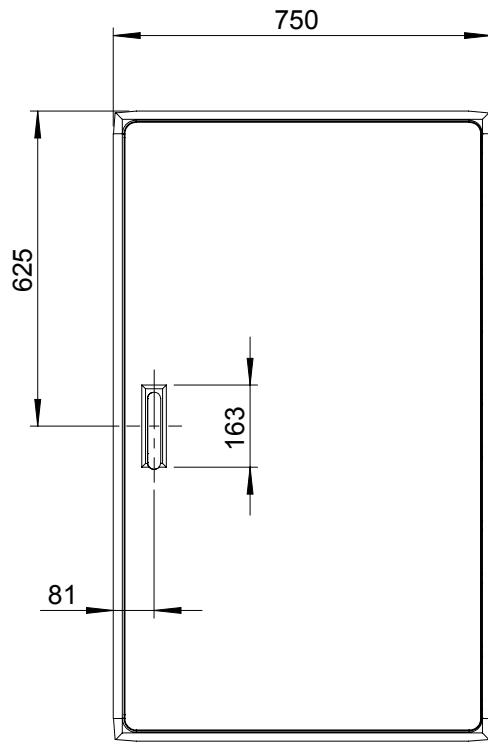

Side view

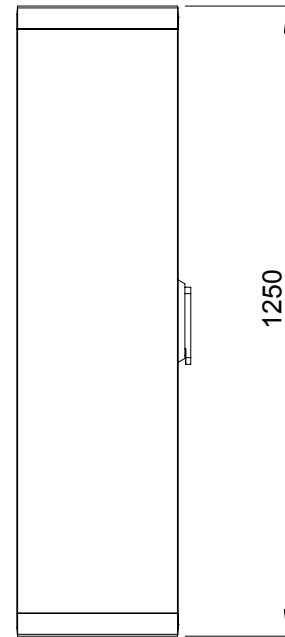

Inside enclosure view

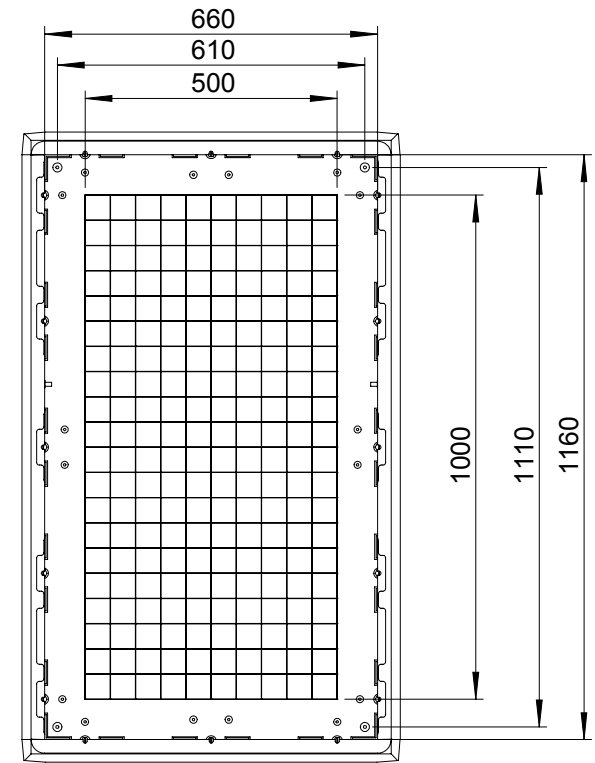

Top view

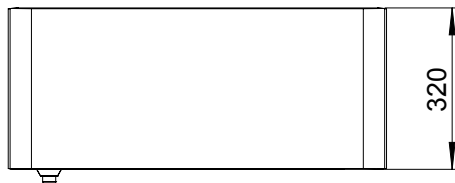

Drawn by : bvgрма	Date: 19-01-2015	Finish: RAL 7035	SCALE:1:15	General tolerances according to Norm ISO 2768-1		
Checked by : mderpu	Date: 19-01-2015					
Revision : 01				Fine	Medium	Coarse
		Fiber-glass reinforced polyester Enclosure, Modular version		Reference number : UDP12575		A4
		1250 mm x 750 mm x 320 mm				
					Page 1/1	