

Front view

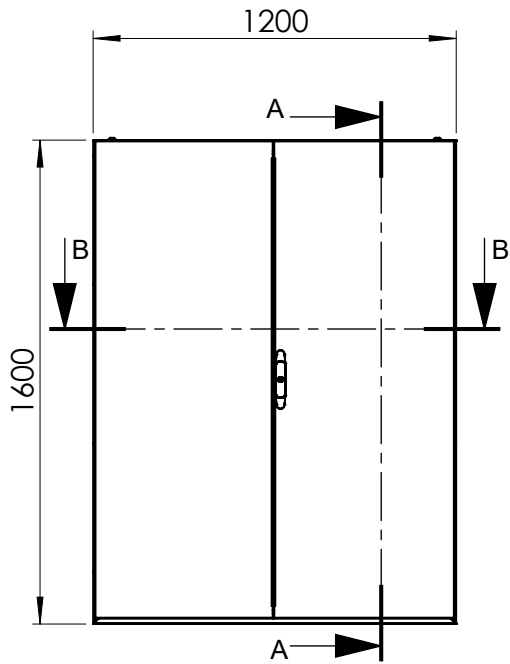

Side view

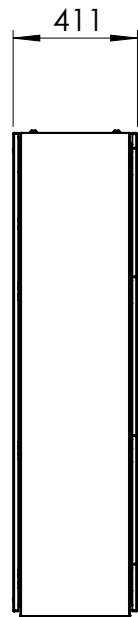

Sectional side view

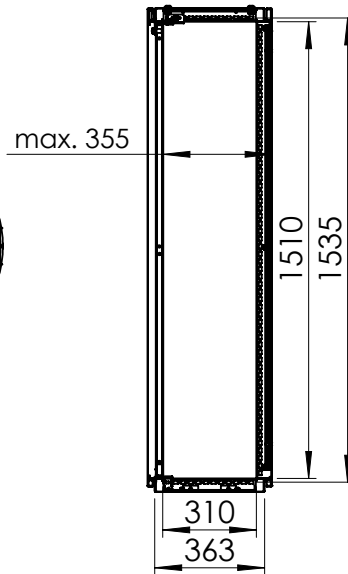

SECTION A-A

Inside left door view

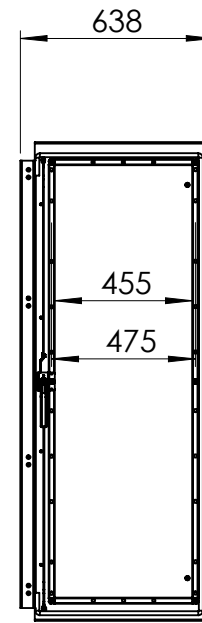

Inside right door view

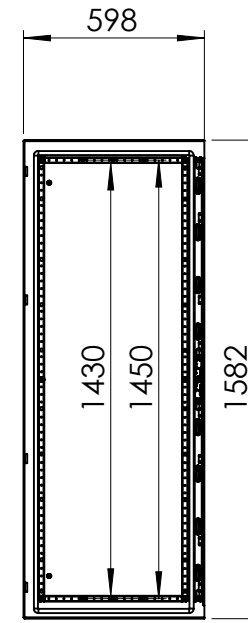

Mounting plate view

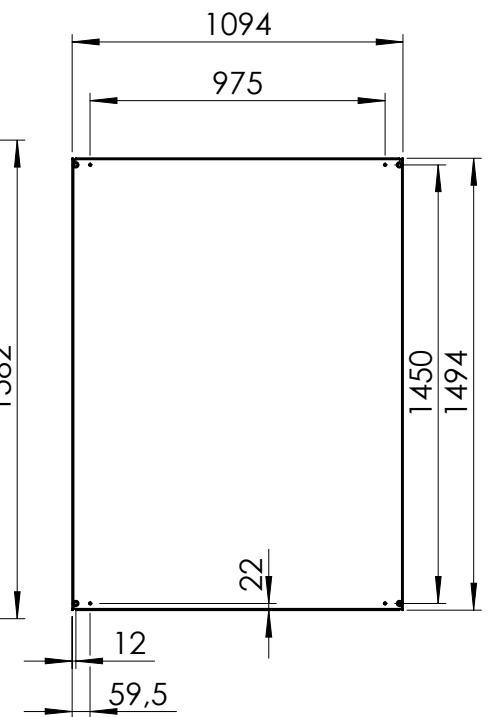

Top view

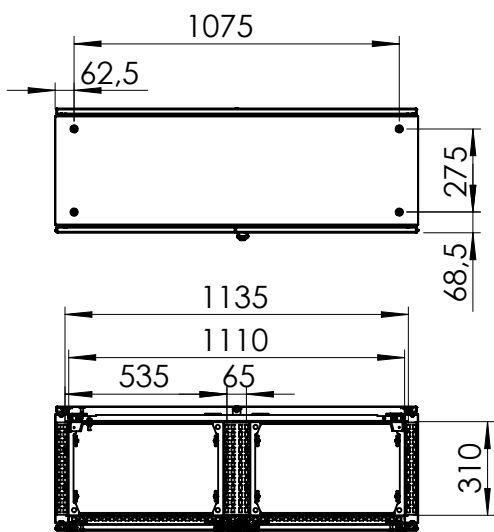

SECTION B-B

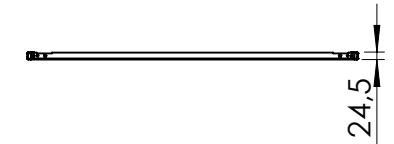

Drawn by : bvacro	Date: 05-12-2016	Finish : 240s pre-grained stainless steel	SCALE:1:25	General tolerances according to Norm ISO 2768-1		
Checked by : mdrojo	Date: 05-12-2016					
Revision				Fine	Medium	Coarse
		Floor Standing, Stainless steel compact version, Double door enclosure		Reference number :		
		1600 mm x 1200 mm x 400 mm		EKDS16124 EKDS16124-316		
				Page 1/1		

A4