

SECTION A-A

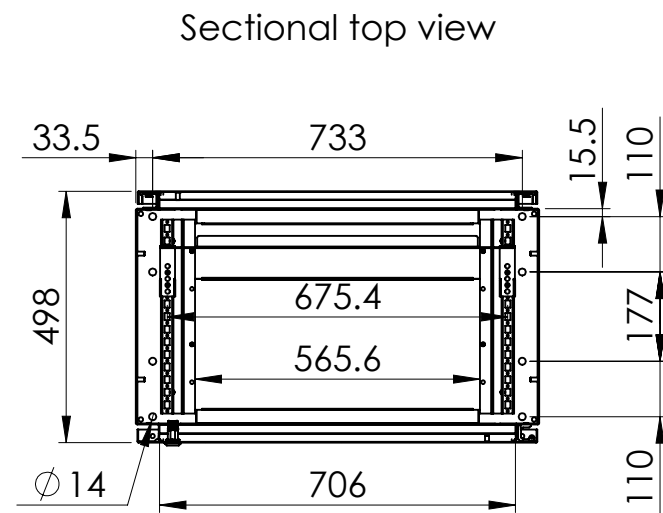
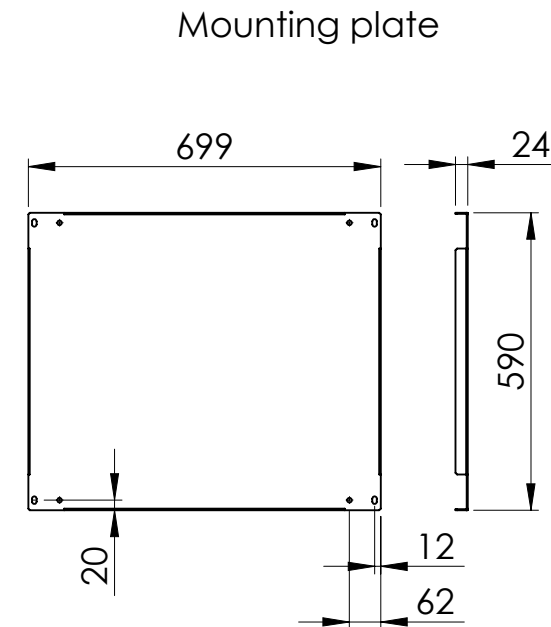
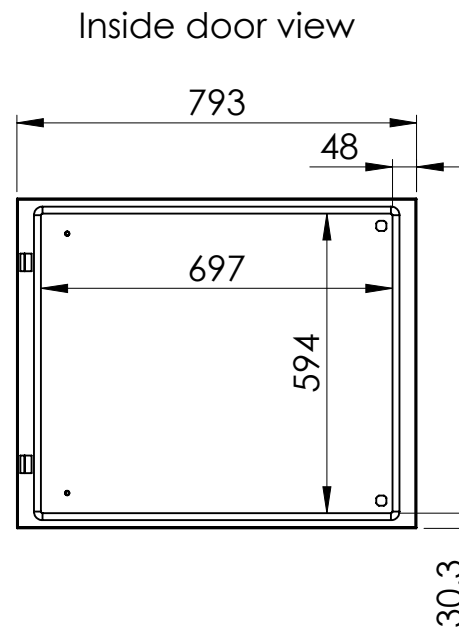

SECTION B-B

Drawn by: bvbura	Date: 05-04-2017	Finish:	SCALE:1:15	General tolerances according to Norm ISO 2768-1		
Checked by: mdmeni	Date: 05-04-2017					
Revision : 01				Fine	Medium	Coarse
		Console systems, Base units, Stainless steel		Reference number : MPCS083 MPCS083-316		A4
		700 mm x 800 mm x 500 mm				
						Page 1/1