

Bottom view

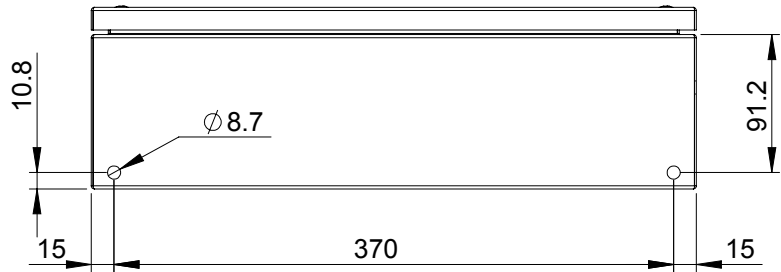

Front view

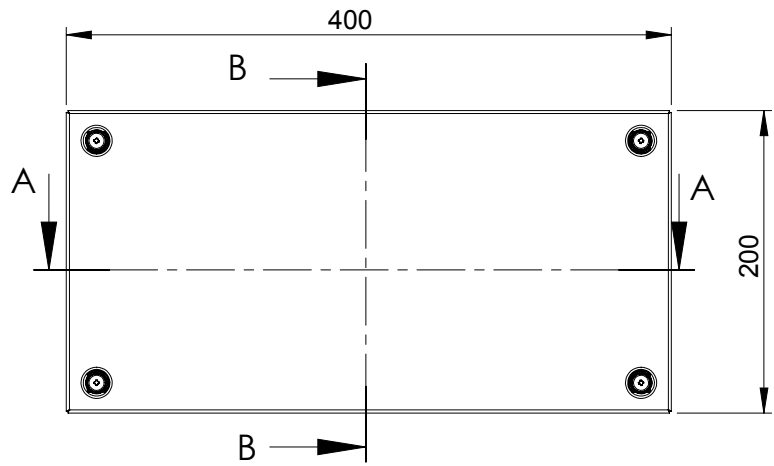

Sectional side view

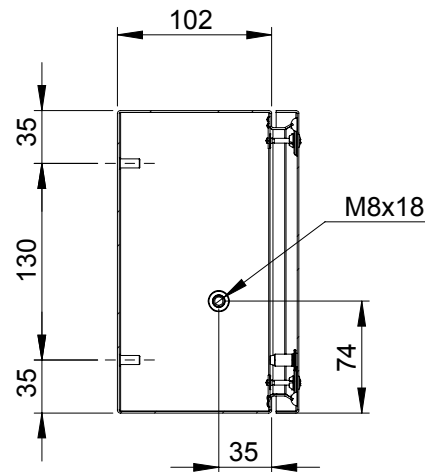

Rear view

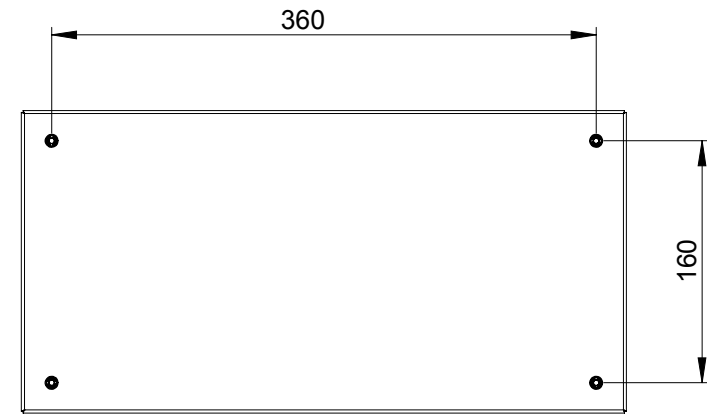

Sectional top view



Section B-B

Drawn by : bvgрма	Date: 25-11-2014	Finish : RAL 7035	SCALE:1:5	General tolerances according to Norm ISO 2768-1		
Checked by : mderpu	Date : 25-11-2014					
Revision : 01				Fine	Medium	Coarse
			Steel terminal box	Reference number : STB204012		A4
			200 mm x 400 mm x 120 mm			
				Page 1/1		