

Bottom view

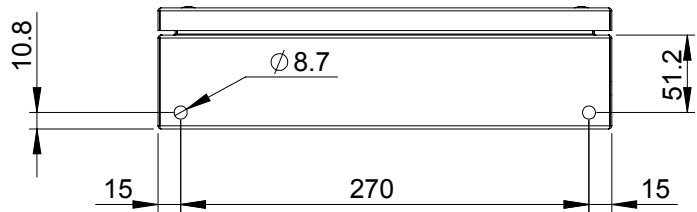

Front view

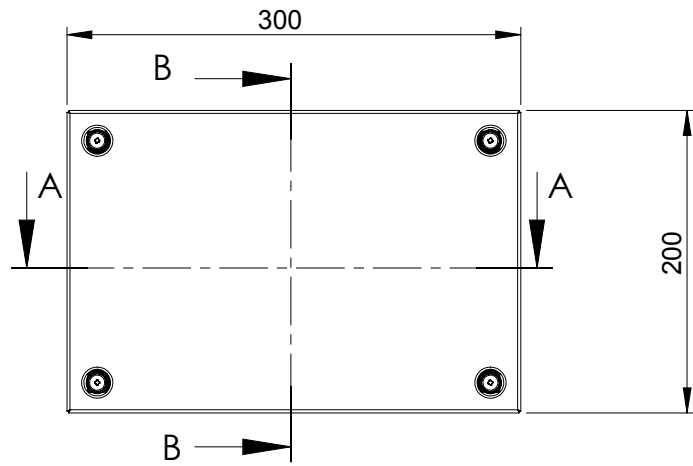

Sectional side view

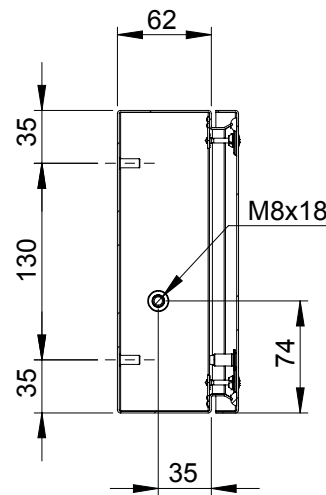

Rear view

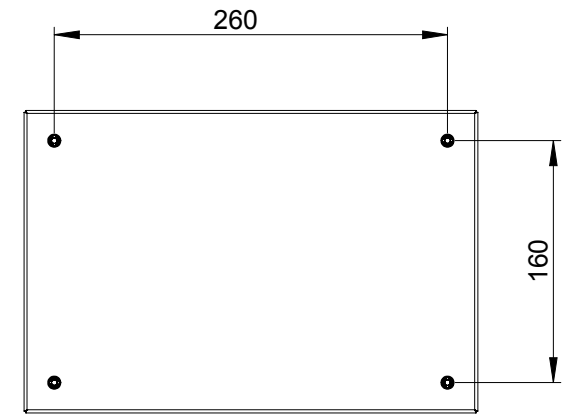

Sectional top view

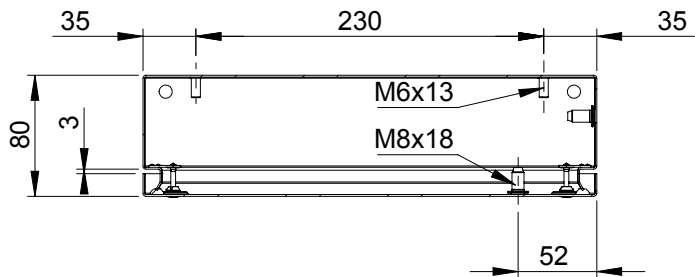

Section B-B

Section A-A

Drawn by : bvgma	Date: 25-11-2014	Finish : RAL 7035	SCALE:1:5	General tolerances according to Norm ISO 2768-1		
Checked by : mderpu	Date : 25-11-2014					
Revision : 01				Fine	Medium	Coarse
			Steel terminal box		Reference number : STB203008	A4
			200 mm x 300 mm x 80 mm			
					Page 1/1	