

Bottom view

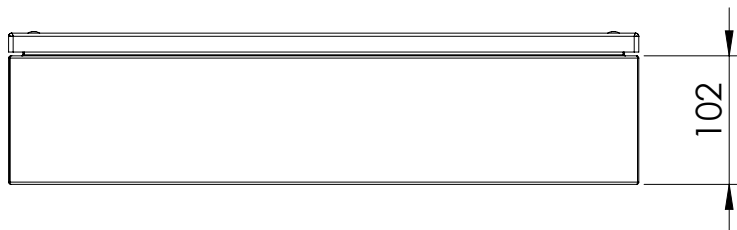

Front view

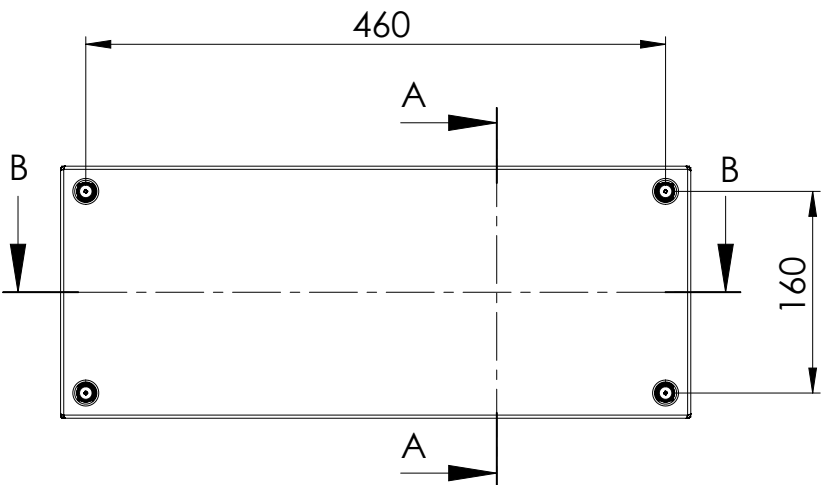

Sectional side view

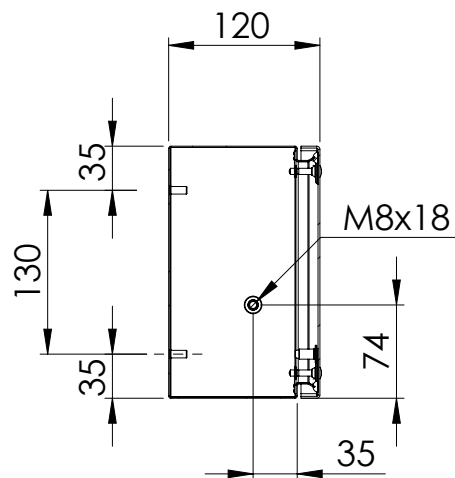

Rear view

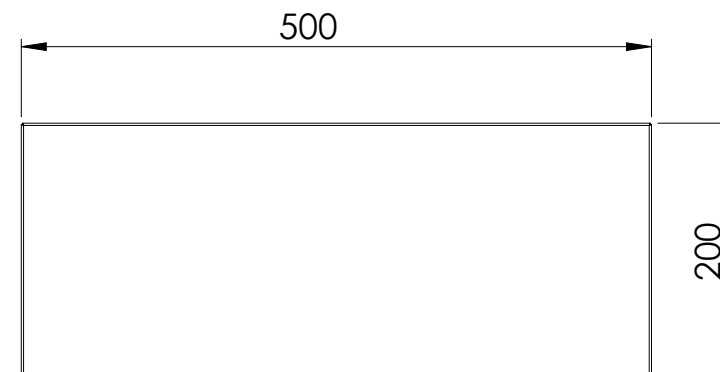

Sectional top view

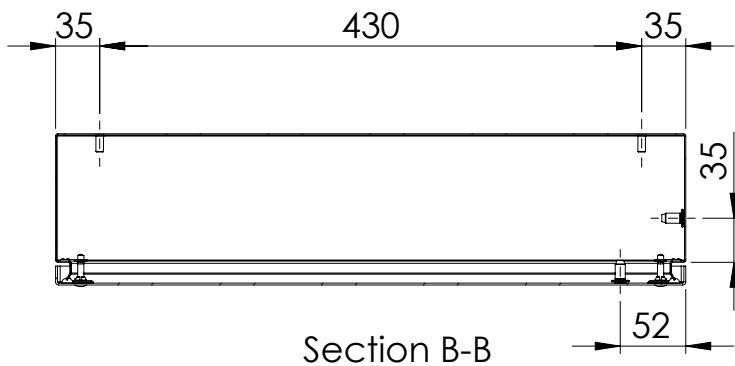

Section A-A

Drawn by : bvgрма	Date: 25-01-2013	Finish : 240s Pre grained Stainless steel	SCALE:1:6	General tolerances according to Norm ISO 2768-1		
Checked by : mderpu	Date : 25-01-2013					
Revision : 01				Fine	Medium	Coarse
		Stainless steel terminal box		Reference number : SSTB205012 SSTB205012-316		A4
		200 mm x 500 mm x 120 mm				
					Page 1/1	