

Bottom view

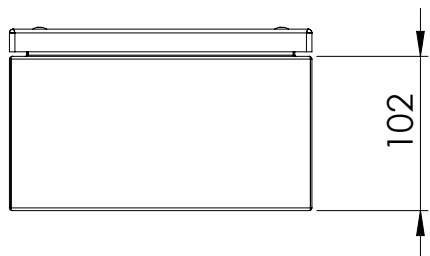

Front view

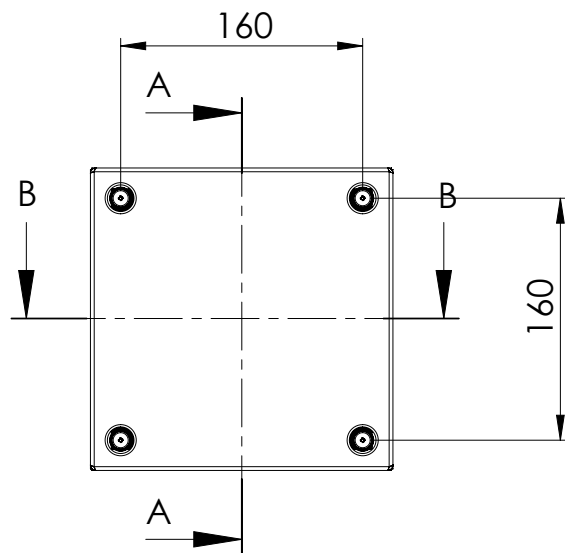

Sectional side view

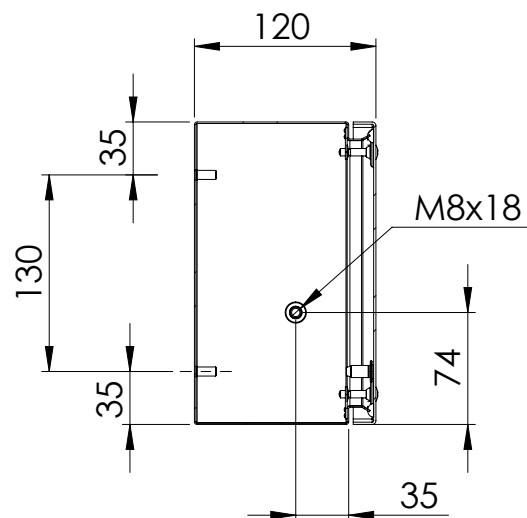

Rear view

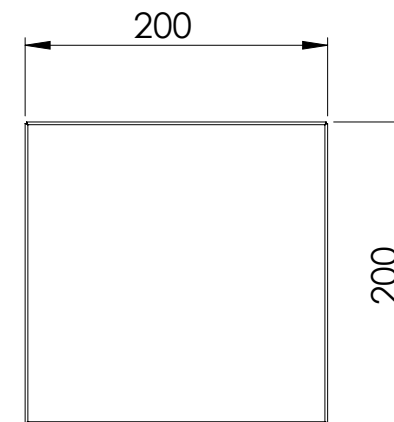

Sectional top view

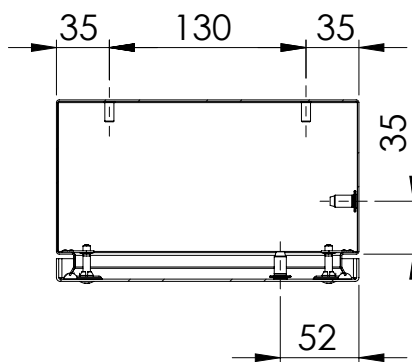

Section A-A

Section B-B

Drawn by : bvgрма	Date: 25-01-2013	Finish : 240s Pre grained Stainless steel	SCALE:1:5	General tolerances according to Norm ISO 2768-1		
Checked by : mderpu	Date : 25-01-2013					
Revision : 01				Fine	Medium	Coarse
		Stainless steel terminal box		Reference number : SSTB202012 SSTB202012-316		A4
		200 mm x 200 mm x 120 mm				
						Page 1/1