

ADO202/ADO202S

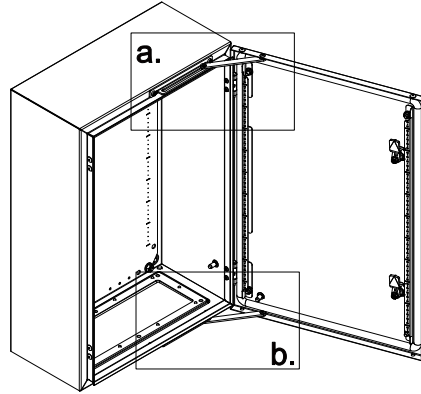

Ref.	Pic.	Qty.
A		1
B		1
C		2
D		2
E		2
F		1
G		1
H		1
I		1
J		1

	90°	110°
X (mm)	83	65

Top mounting

Bottom mounting

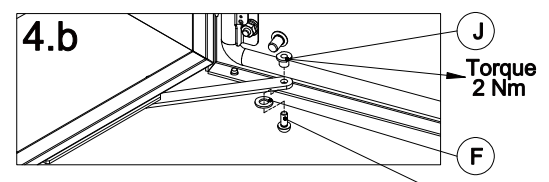
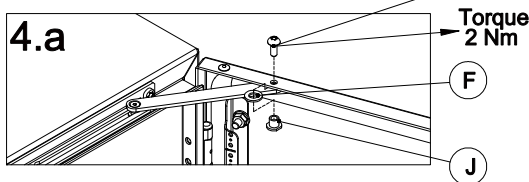
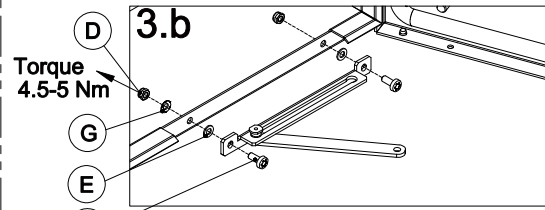
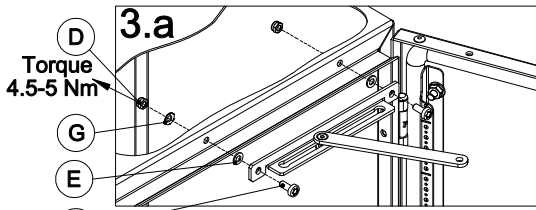
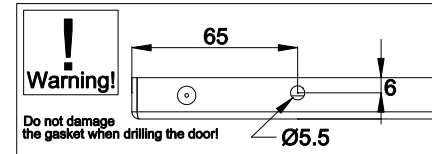
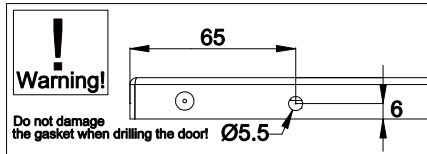
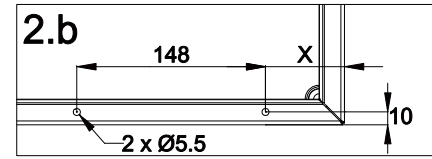
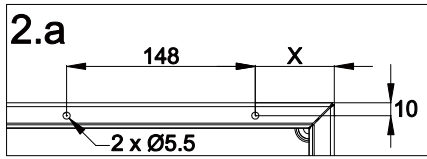
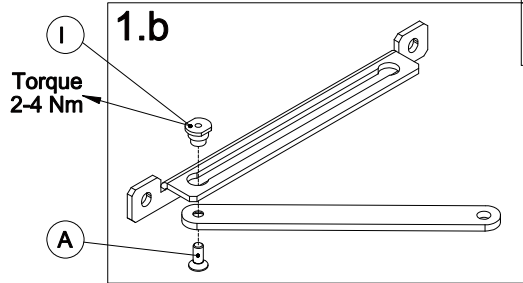
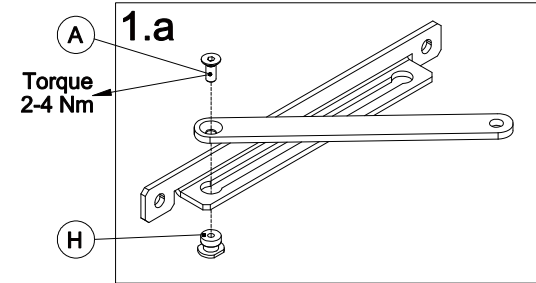

- Mount the ADO at the bottom, for enclosures 1000mm high and above.

