

ID	Description	Date	By	Appr.
A				

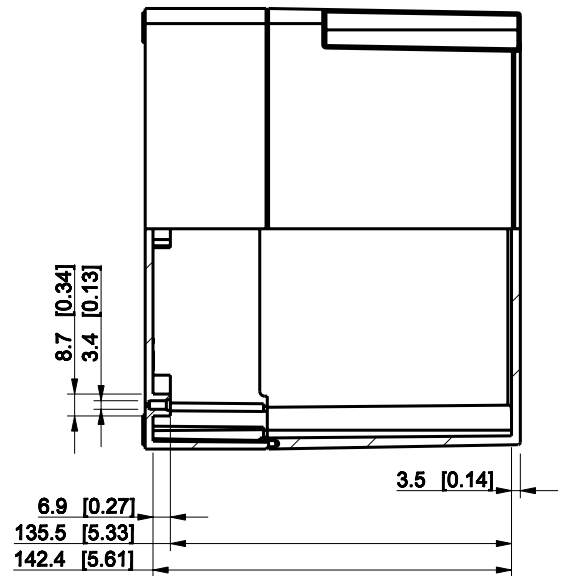
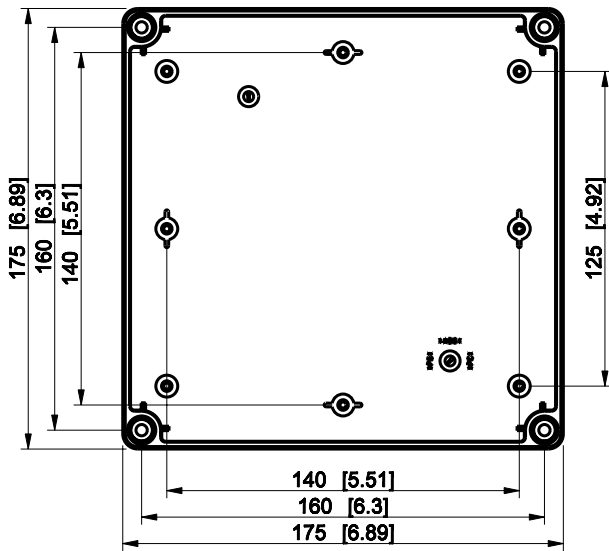
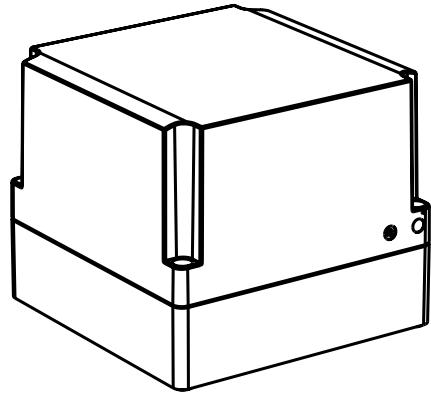
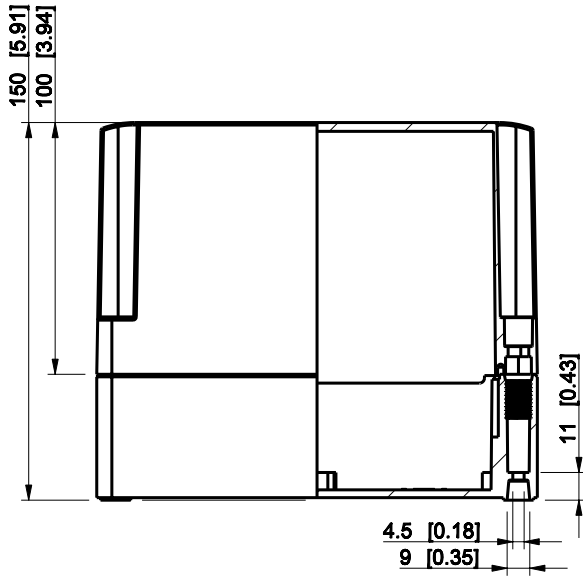

Dimensions in mm [inches]

Material: ABS	Color: RAL 7035
---------------	-----------------

Supplier:	Tool No:	Weight [kg]: 0.65	Volume:
-----------	----------	-------------------	---------

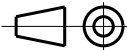

SABP181815G

Scale	Date	08.12.08
1:3	By	PKos
-	Checked	
-	Ctrl	

Replaces:
Replaced:
Drw No: - A
Ref: Cubo S
Code: SABP181815G
Sheet No:

model SABP181815G PART
 drawing CUBOS DRAWING