

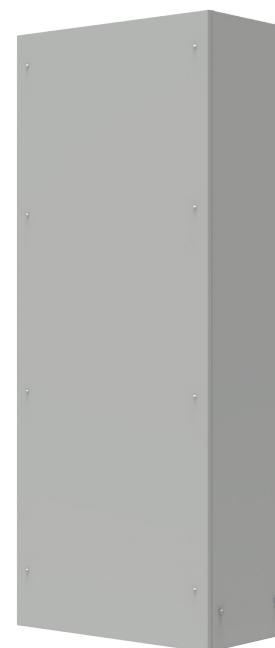

# EXW - Indoor

Scambiatori Di Calore Aria/Acqua - Air/Water Heat Exchangers - Luft/Wasser Wärmetauscher-  
Intercambiadore de calor Aire/Agua



## Caratteristiche Generali

- Capacità frigorifere: 870-25000 W
- Installazione a parete o a tetto (EXW15H0 ed EXW50H0)

## Common Features

- Cooling capacity 870-25000 W
- Wall or top mounting (EXW15H0 ed EXW50H0)

## Allgemeine Merkmale

- Kälteleistung 870-25000 W
- Wand- und Dachmontage (EXW15H0 ed EXW50H0)

## Características Comunes

- Potencia frigorífica: 870-25000 W
- Montaje en pared o techo

## Certificazioni - Certifications - Zertifizierungen - Certificaciones

- CE
- EAC
- UL Listed ( Codice - Code - Artikelnummer - Código = EXW--U----- )





## OPTIONAL

CODICE - CODE ARTIKELNUMMER - CODIGO	Colore Speciale - Special Colour Sonderfarbe - Color Especial	Valvola Solenoide + Termostato Sole- noid Valve + Thermostat Magnetventil + Thermostat Válvula solenoide + Termostato	Carpenteria - Housing - Gehäuse - Carcasa INOX AISI304
EXW06	OCAXNS06	OCAEVT1	OCAXI04
EXW15	OCAXNS08	OCAEVT2	OCAXI05
EXW15H	OCAXNS08	STD	OCAXI05
EXW25	OCAXNS08	OCAEVT2	OCAXI05
EXW50	OCAXNS10	OCAEVT2	OCAXI06
EXW50H	OCAXNS10	STD	OCAXI06
EXWA0	OCAXNS10	OCAEVT4	OCAXI07
EXWA5	OCAXNS11	OCAEVT4	OCAXI07
EXWB0	OCAXNS11	STD	OCAXI07



# EXW06

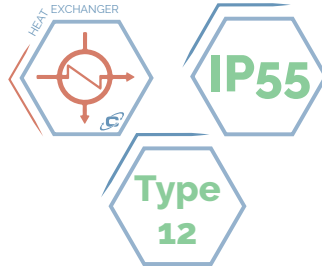

CODICE - CODE - ARTIKELNUMMER - CÒDIGO	M.U.	EXW0600220	EXW06U1220	EXW06U1222
UL Listed		--	•	•
Tensione nominale - Rated voltage - Nennspannung - Tensión nominal	V. -	230 . 1	230 . 1	115 . 1
Frequenza nominale - Nominal frequency - Nennfrequenz - Frecuencia nominal	Hz	50 60	50/60	60
Potenza frigorifera - Cooling capacity - Kühlleistung - Potencia frigorífica	$\Delta T=25^{\circ}C$ W	870	870	870
Corrente Assorbita - Absorbed Current - Stromaufnahme - Corriente absorbida	A	0,28 0,24	0,5	0,5
Fusibile T - T Preufse - Absicherung - Fusibile T	A	2	2	2
Potenza Assorbita dal ventilatore - Absorbed fan Power - Leistungsaufnahme des Lüfter - Potencia absorbida del ventilador	W	33 36	25	24
Portata Acqua - Water flow - Wassermenge - Caudal de agua	l/h	150	150	150
Massima pressione acqua - Max water pressure - Max Wasserdruck - Presión Máxima agua	kPa	500	500	500
Perdita di carico - Water pressure drop - Druckverlust Wasserseite - Pérdida de carga lato agua	kPa	2	2	2
Temp. interne di funzionamento - Internal operating temp. - Interne Betriebstemperatur - Temp. internas de funcionamiento	min/ max °C	+10 / +55	+10 / +55	+10 / +55
Attacchi lato acqua - Water connection diam. - Wasseranschlüsse - Uniones lado agua	"	3 / 8	3 / 8 NPT	3 / 8 NPT
Grado di protezione circuito interno - Internal circuit protection rating - Schutzgrad interner Kreislauf - Grado de protección del circuito interno	CE IP	55	--	--
	UL Type	--	12	12
Pressione sonora esterna - External sound pressure - Externer Schalldruck - Presión sonora externa	dB(A)	35	35	35
Altezza / Larghezza / Profondità - Height / Width / Depth - Höhe / Breite / Tiefe - Altura / Anchura / Profundidad	mm	403 x 306 x 113	403 x 306 x 113	403 x 306 x 113
Peso - Weight - Gewicht - Peso	kg	7	7	7

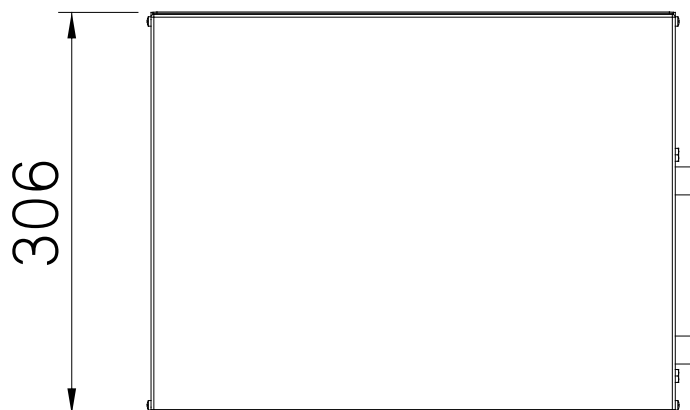
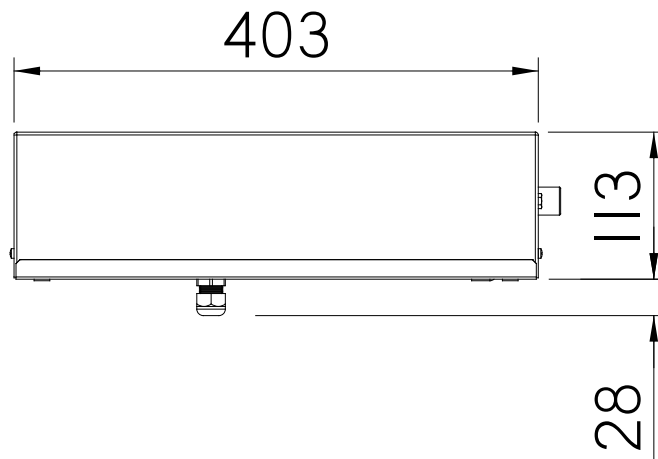

# EXW15

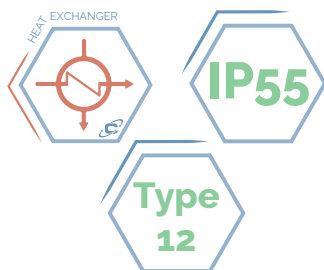

CODICE - CODE - ARTIKELNUMMER - CÒDIGO	M.U.	EXW1500220	EXW15U1220	EXW15U1222
<b>UL Listed</b>		--	•	•
Tensione nominale - Rated voltage - Nennspannung - Tensión nominal	V, -	230, 1	230, 1	115, 1
Frequenza nominale - Nominal frequency - Nennfrequenz - Frecuencia nominal	Hz	50 60	50/60	60
Potenza frigorifera - Cooling capacity - Kühlleistung - Potencia frigorífica	ΔT=25°C W	2200	2200	2200
Corrente Assorbita - Absorbed Current - Stromaufnahme - Cirriente absorbida	A	0,23 0,29	0,8	0,8
Fusibile T - T Preufse - Absicherung - Fusibile T	A	2	2	2
Potenza Assorbita dal ventilatore - Absorbed fan Power - Leistungsaufnahme des Lüfter - Potencia absorbida del ventilador	W	52 65	75	90
Portata Acqua - Water flow - Wassermenge - Caudal de agua	l/h	150	150	150
Massima pressione acqua - Max water pressure - Max Wasserdruck - Presión Máxima agua	kPa	1000	1000	1000
Perdita di carico - Water pressure drop - Druckverlust Wasserseite - Pérdida de carga lato agua	kPa	30	30	30
Temp. interne di funzionamento - Internal operating temp. - Interne Betriebstemperatur - Temp. internas de funcionamiento	min/ max °C	+10 / +55	+10 / +55	+10 / +55
Attacchi lato acqua - Water connection diam. - Wasseranschlüsse - Uniones lado agua	"	1 / 2	1 / 2 NPT	1 / 2 NPT
Grado di protezione circuito interno - Internal circuit protection rating - Schutzgrad interner Kreislauf - Grado de protección del circuito interno	CE IP	55	--	--
	UL Type	--	12	12
Pressione sonora esterna - External sound pressure - Externer Schalldruck - Presión sonora externa	dB(A)	45	45	45
Altezza / Larghezza / Profondità - Height / Width / Depth - Höhe / Breite / Tiefe - Altura / Anchura / Profundidad	mm	916 x 402 x 206	916 x 402 x 206	916 x 402 x 206
Peso - Weight - Gewicht - Peso	kg	20	21	21

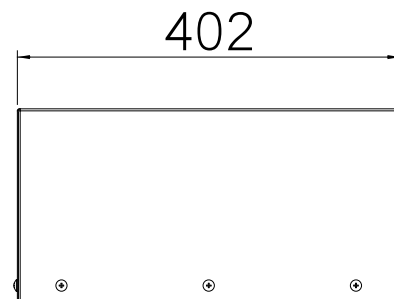
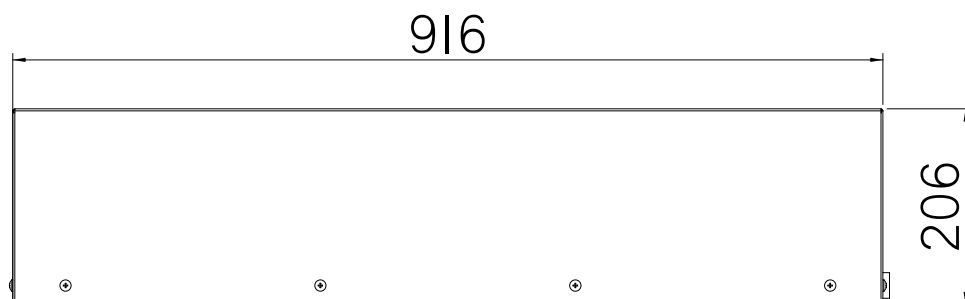



# EXW25

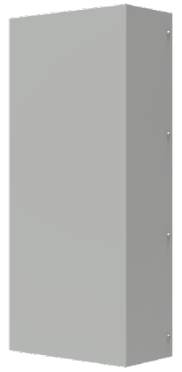
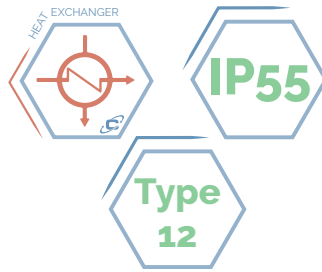

CODICE - CODE - ARTIKELNUMMER - CÒDIGO	M.U.	EXW2500220	EXW25U1220	EXW25U1222
UL Listed		--	•	•
Tensione nominale - Rated voltage - Nennspannung - Tensión nominal	V. -	230 . 1	230 . 1	115 . 1
Frequenza nominale - Nominal frequency - Nennfrequenz - Frecuencia nominal	Hz	50 60	50/60	60
Potenza frigorifera - Cooling capacity - Kühlleistung - Potencia frigorífica	ΔT=25°C W	3100	3100	3100
Corrente Assorbita - Absorbed Current - Stromaufnahme - Corriente absorbida	A	0,36 0,46	1	1
Fusibile T - T Preufse - Absicherung - Fusibile T	A	2	4	4
Potenza Assorbita dal ventilatore - Absorbed fan Power - Leistungsaufnahme des Lüfter - Potencia absorbida del ventilador	W	80 100	90	115
Portata Acqua - Water flow - Wassermenge - Caudal de agua	l/h	500	500	500
Massima pressione acqua - Max water pressure - Max Wasserdruck - Presión Máxima agua	kPa	1000	1000	1000
Perdita di carico - Water pressure drop - Druckverlust Wasserseite - Pérdida de carga lato agua	kPa	63	63	63
Temp. interne di funzionamento - Internal operating temp. - Interne Betriebstemperatur - Temp. internas de funcionamiento	min/ max °C	+10 / +55	+10 / +55	+10 / +55
Attacchi lato acqua - Water connection diam. - Wasseranschlüsse - Uniones lado agua	"	1 / 2	1 / 2 NPT	1 / 2 NPT
Grado di protezione circuito interno - Internal circuit protection rating - Schutzgrad interner Kreislauf - Grado de protección del circuito interno	CE IP	55	--	--
	UL Type	--	12	12
Pressione sonora esterna - External sound pressure - Externer Schalldruck - Presión sonora externa	dB(A)	45	45	45
Altezza / Larghezza / Profondità - Height / Width / Depth - Höhe / Breite / Tiefe - Altura / Anchura / Profundidad	mm	916 x 402 x 206	916 x 402 x 206	916 x 402 x 206
Peso - Weight - Gewicht - Peso	kg	21	22	22

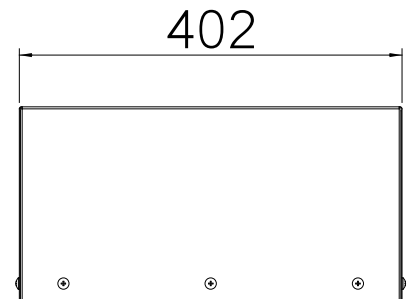
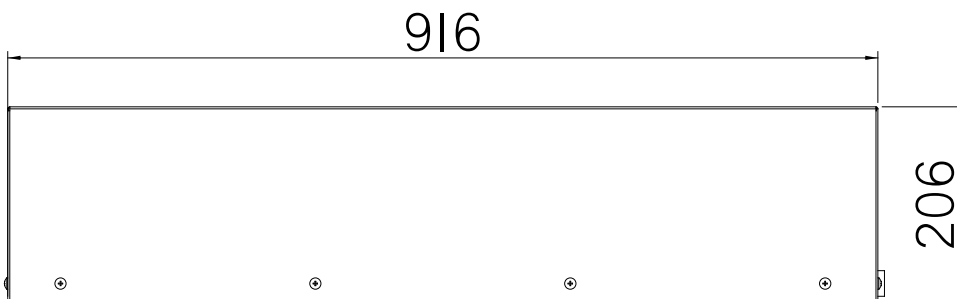

# EXW50

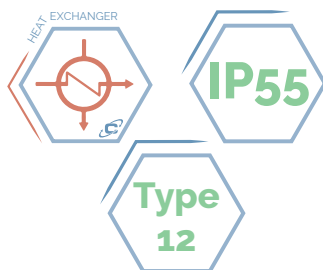

CODICE - CODE - ARTIKELNUMMER - CÒDIGO	M.U.	EXW5000220	EXW50U1220	EXW50U1222
UL Listed		--	•	•
Tensione nominale - Rated voltage - Nennspannung - Tensión nominal	V. -	230 . 1	230 . 1	115 . 1
Frequenza nominale - Nominal frequency - Nennfrequenz - Frecuencia nominal	Hz	50 60	50/60	60
Potenza frigorifera - Cooling capacity - Kühlleistung - Potencia frigorífica	ΔT=25°C W	6700	6700	6700
Corrente Assorbita - Absorbed Current - Stromaufnahme - Cirriente absorbida	A	1,02 1,5	1,3	2
Fusibile T - T Preufse - Absicherung - Fusibile T	A	4	4	4
Potenza Assorbita dal ventilatore - Absorbed fan Power - Leistungsaufnahme des Lüfter - Potencia absorbida del ventilador	W	230 340	285	155
Portata Acqua - Water flow - Wassermenge - Caudal de agua	l/h	860	860	860
Massima pressione acqua - Max water pressure - Max Wasserdruck - Presión Máxima agua	kPa	1000	1000	1000
Perdita di carico - Water pressure drop - Druckverlust Wasserseite - Pérdida de carga lato agua	kPa	40	40	40
Temp. interne di funzionamento - Internal operating temp. - Interne Betriebstemperatur - Temp. internas de funcionamiento	min/ max °C	+10 / +55	+10 / +55	+10 / +55
Attacchi lato acqua - Water connection diam. - Wasseranschlüsse - Uniones lado agua	"	1 / 2	1 / 2 NPT	1 / 2 NPT
Grado di protezione circuito interno - Internal circuit protection rating - Schutzgrad interner Kreislauf - Grado de protección del circuito interno	CE IP	55	--	--
	UL Type	--	12	12
Pressione sonora esterna - External sound pressure - Externer Schalldruck - Presión sonora externa	dB(A)	45	45	45
Altezza / Larghezza / Profondità - Height / Width / Depth - Höhe / Breite / Tiefe - Altura / Anchura / Profundidad	mm	1091 x 503 x 293	1091 x 503 x 293	1091 x 503 x 293
Peso - Weight - Gewicht - Peso	kg	39	39	39

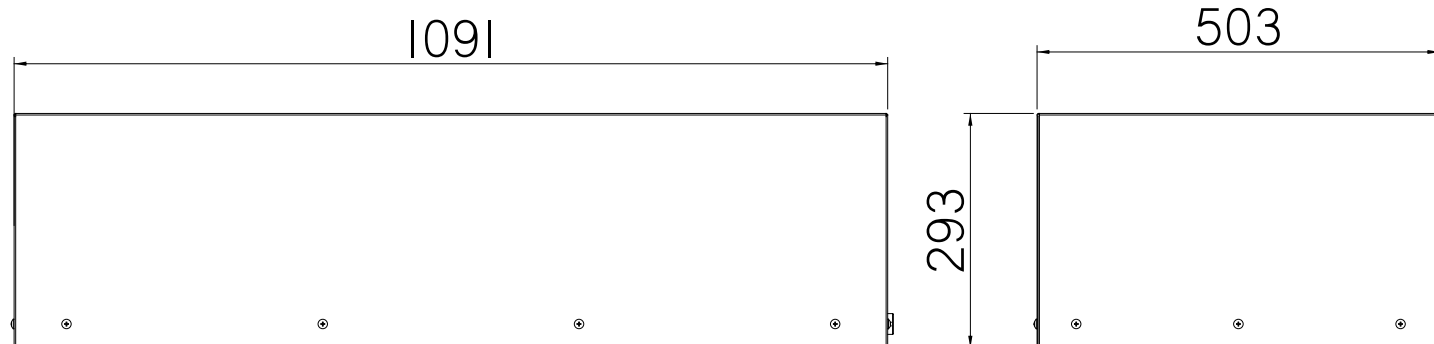



# EXWAO

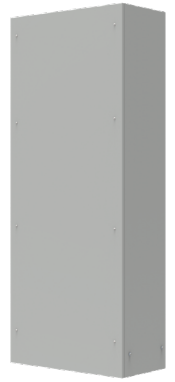
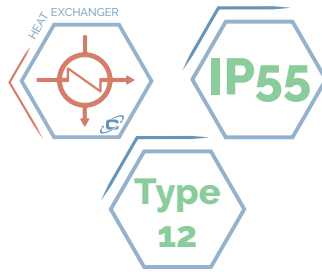

CODICE - CODE - ARTIKELNUMMER - CÒDIGO	M.U.	EXWA000220	EXWA000230	EXWA0U1220	EXWA0U1222
<b>UL Listed</b>		--	--	•	•
Tensione nominale - Rated voltage - Nennspannung - Tensión nominal	V. ~	230 . 1	400 . 2 460 . 2	230 . 1	115 . 1
Frequenza nominale - Nominal frequency - Nennfrequenz - Frecuencia nominal	Hz	50 60	50 60	50/60	60
Potenza frigorifera - Cooling capacity - Kühlleistung - Potencia frigorífica	ΔT=25°C W	12500	12500	12500	12500
Corrente Assorbita - Absorbed Current - Stromaufnahme - Corriente absorbida	A	2 3	1 1,18	3	5,5
Fusibile T - T Preufse - Absicherung - Fusibile T	A	4	4	15	15
Potenza Assorbita dal ventilatore - Absorbed fan Power - Leistungsaufnahme des Lüfter - Potencia absorbida del ventilador	W	460 680	460 680	570	390
Portata Acqua - Water flow - Wassermenge - Caudal de agua	l/h	1440	1440	1440	1440
Massima pressione acqua - Max water pressure - Max Wasserdruck - Presión Máxima agua	kPa	1000	1000	1000	1000
Perdita di carico - Water pressure drop - Druckverlust Wasserseite - Pérdida de carga lato agua	kPa	90	90	90	90
Temp. interne di funzionamento - Internal operating temp. - Interne Betriebstemperatur - Temp. internas de funcionamiento	min/ max °C	+10 / +55	+10 / +55	+10 / +55	+10 / +55
Attacchi lato acqua - Water connection diam. - Wasseranschlüsse - Uniones lado agua	"	3 / 4	3 / 4	3 / 4 NPT	3 / 4 NPT
Grado di protezione circuito interno - Internal circuit protection rating - Schutzgrad interner Kreislauf - Grado de protección del circuito interno	CE IP	54	54	--	--
	UL Type	--	--	12	12
Pressione sonora esterna - External sound pressure - Externer Schalldruck - Presión sonora externa	dB(A)	50	50	50	50
Altezza / Larghezza / Profondità - Height / Width / Depth - Höhe / Breite / Tiefe - Altura / Anchura / Profundidad	mm	2000x800x400	2000x800x400	2000x800x400	2000x800x400
Peso - Weight - Gewicht - Peso	kg	90	90	90	90

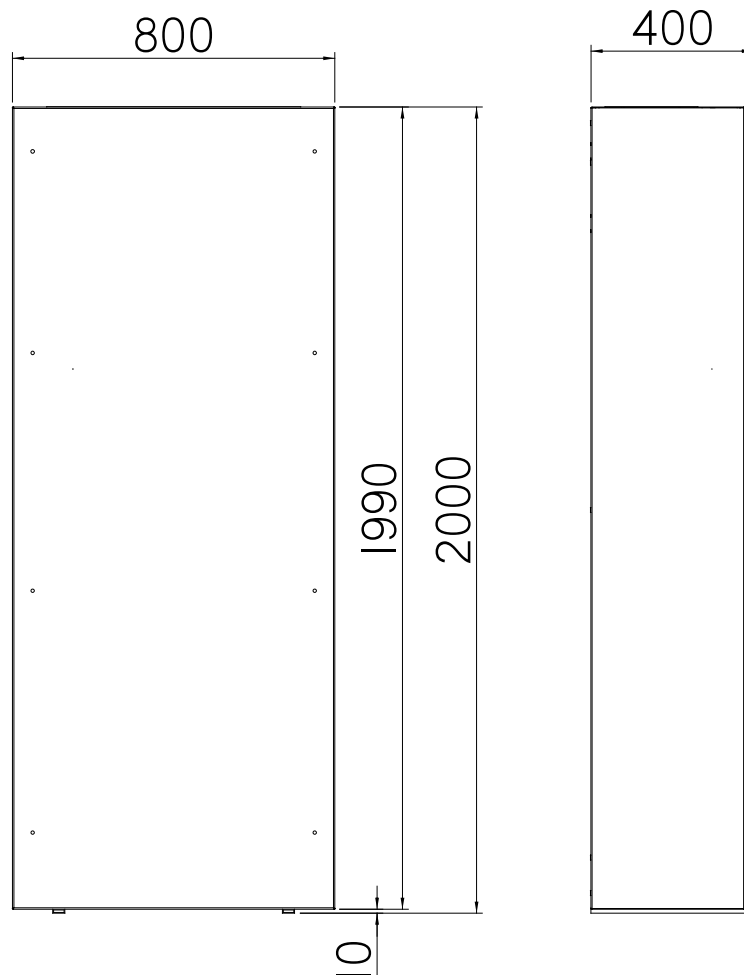

# EXWA5

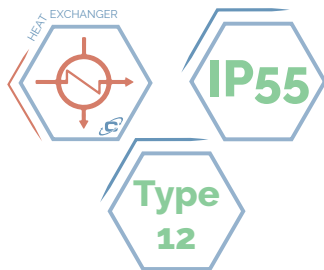

CODICE - CODE - ARTIKELNUMMER - CÒDIGO	M.U.	EXWA500220	EXWA500230
UL Listed		--	--
Tensione nominale - Rated voltage - Nennspannung - Tensión nominal	V, -	230 , 1	400 , 2    460 , 2
Frequenza nominale - Nominal frequency - Nennfrequenz - Frecuencia nominal	Hz	50        60	50        60
Potenza frigorifera - Cooling capacity - Kühlleistung - Potencia frigorífica	ΔT=25°C W	17500	17500
Corrente Assorbita - Absorbed Current - Stromaufnahme - Corriente absorbida	A	0,78        1,1	0,42        0,56
Fusibile T - T Preufse - Absicherung - Fusibile T	A	4	4
Potenza Assorbita dal ventilatore - Absorbed fan Power - Leistungsaufnahme des Lüfter - Potencia absorbida del ventilador	W	170        250	170        250
Portata Acqua - Water flow - Wassermenge - Caudal de agua	l/h	2520	2520
Massima pressione acqua - Max water pressure - Max Wasserdruck - Presión Máxima agua	kPa	1000	1000
Perdita di carico - Water pressure drop - Druckverlust Wasserseite - Pérdida de carga lato agua	kPa	121	121
Temp. interne di funzionamento - Internal operating temp. - Interne Betriebstemperatur - Temp. internas de funcionamiento	min/ max °C	+10 / +55	+10 / +55
Attacchi lato acqua - Water connection diam. - Wasseranschlüsse - Uniones lado agua	"	3 / 4	3 / 4
Grado di protezione circuito interno - Internal circuit protection rating - Schutzgrad interner Kreislauf - Grado de protección del circuito interno	CE    IP	54	54
	UL    Type	--	--
Pressione sonora esterna - External sound pressure - Externer Schalldruck - Presión sonora externa	dB(A)	50	50
Altezza / Larghezza / Profondità - Height / Width / Depth - Höhe / Breite / Tiefe - Altura / Anchura / Profundidad	mm	2000 x 800 x 600	2000 x 800 x 600
Peso - Weight - Gewicht - Peso	kg	90	90

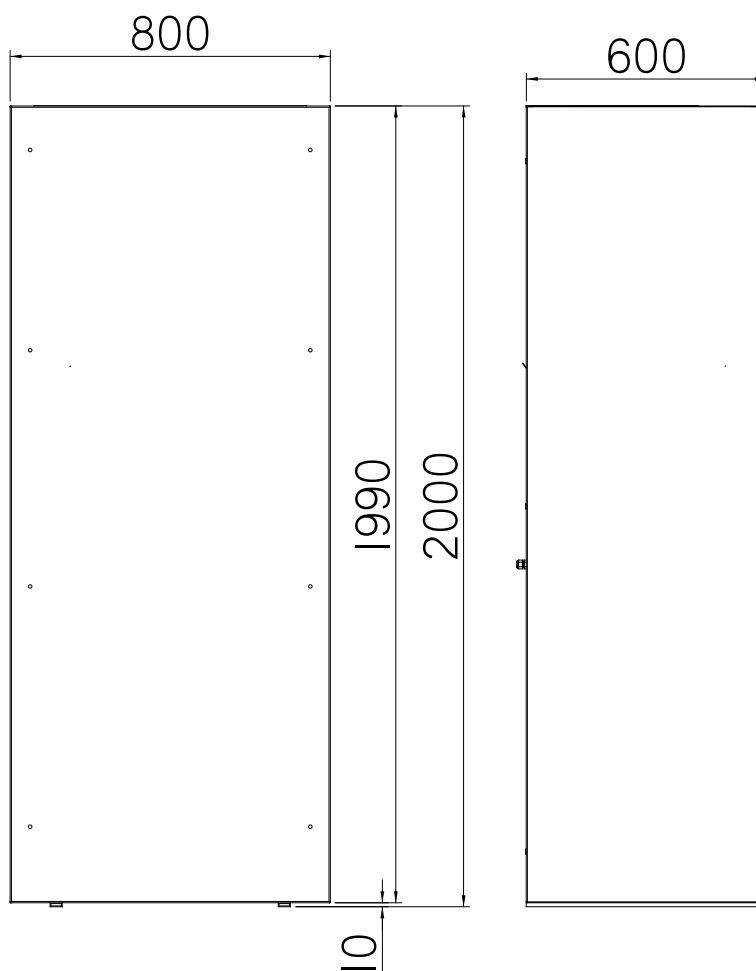





# EXWBo

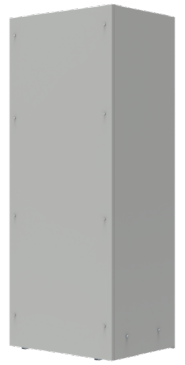
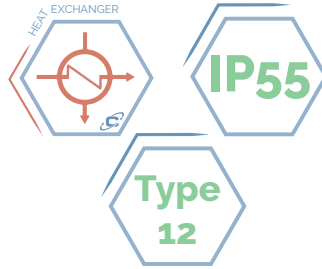

CODICE - CODE - ARTIKELNUMMER - CÒDIGO	M.U.	EXWB000220		EXWB000230	
UL Listed		--		--	
Tensione nominale - Rated voltage - Nennspannung - Tensión nominal	V, -	230, 1		400, 2	460, 2
Frequenza nominale - Nominal frequency - Nennfrequenz - Frecuencia nominal	Hz	50	60	50	60
Potenza frigorifera - Cooling capacity - Kühlleistung - Potencia frigorífica	$\Delta T=25^{\circ}\text{C}$ W	25000		25000	
Corrente Assorbita - Absorbed Current - Stromaufnahme - Corriente absorbida	A	2,2	2,8	0,85	1,13
Fusibile T - T Preufse - Absicherung - Fusibile T	A	4		4	
Potenza Assorbita dal ventilatore - Absorbed fan Power - Leistungsaufnahme des Lüfter - Potencia absorbida del ventilador	W	340	500	340	500
Portata Acqua - Water flow - Wassermenge - Caudal de agua	l/h	1800		1800	
Massima pressione acqua - Max water pressure - Max Wasserdruck - Presión Máxima agua	kPa	1000		1000	
Perdita di carico - Water pressure drop - Druckverlust Wasserseite - Pérdida de carga lato agua	kPa	65		65	
Temp. interne di funzionamento - Internal operating temp. - Interne Betriebstemperatur - Temp. internas de funcionamiento	min/ max °C	+10 / +50		+10 / +50	
Attacchi lato acqua - Water connection diam. - Wasseranschlüsse - Uniones lado agua	"	3 / 4		3 / 4	
Grado di protezione circuito interno - Internal circuit protection rating - Schutzgrad interner Kreislauf - Grado de protección del circuito interno	CE IP	54		54	
	UL Type	--		--	
Pressione sonora esterna - External sound pressure - Externer Schalldruck - Presión sonora externa	dB(A)	50		50	
Altezza / Larghezza / Profondità - Height / Width / Depth - Höhe / Breite / Tiefe - Altura / Anchura / Profundidad	mm	2000 x 800 x 600		2000 x 800 x 600	
Peso - Weight - Gewicht - Peso	kg	95		95	

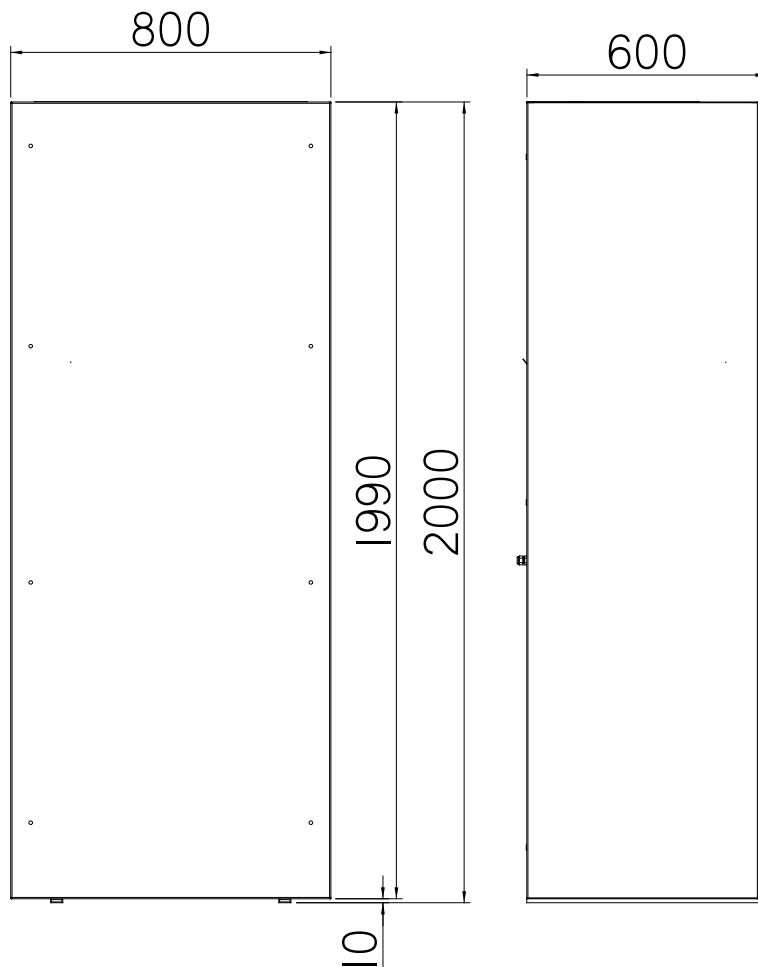



# EXW15H - EXW50H

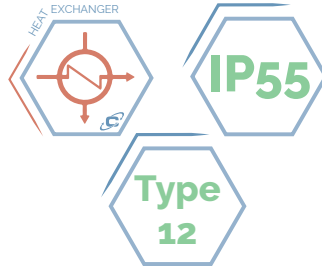

CODICE - CODE - ARTIKELNUMMER - CÒDIGO	M.U.	EXW15H02207000	EXW50H02207000
UL Listed		--	--
Tensione nominale - Rated voltage - Nennspannung - Tensión nominal	V, -	230, 1	230, 1
Frequenza nominale - Nominal frequency - Nennfrequenz - Frecuencia nominal	Hz	50 60	50 60
Potenza frigorifera - Cooling capacity - Kühlleistung - Potencia frigorífica	AT=25°C W	2200	6700
Corrente Assorbita - Absorbed Current - Stromaufnahme - Corriente absorbida	A	0.23 0.29	1.02 1.5
Fusibile T - T Preufse - Absicherung - Fusibile T	A	2	4
Potenza Assorbita dal ventilatore - Absorbed fan Power - Leistungsaufnahme des Lüfter - Potencia absorbida del ventilador	W	52 65	260 340
Portata Acqua - Water flow - Wassermenge - Caudal de agua	l/h	150	860
Massima pressione acqua - Max water pressure - Max Wasserdruck - Presión Máxima agua	kPa	1000	1000
Perdita di carico - Water pressure drop - Druckverlust Wasserseite - Pérdida de carga lato agua	kPa	30	30
Temp. interne di funzionamento - Internal operating temp. - Interne Betriebstemperatur - Temp. internas de funcionamiento	min/ max °C	+10 / +65	+10 / +55
Attacchi lato acqua - Water connection diam. - Wasseranschlüsse - Uniones lado agua	"	1 / 2	1 / 2
Grado di protezione circuito interno - Internal circuit protection rating - Schutzgrad interner Kreislauf - Grado de protección del circuito interno	CE IP	54	54
	UL Type	--	--
Pressione sonora esterna - External sound pressure - Externer Schalldruck - Presión sonora externa	dB(A)	45	45
Altezza / Larghezza / Profondità - Height / Width / Depth - Höhe / Breite / Tiefe - Altura / Anchura / Profundidad	mm	189 x 772 x 404	255 x 905 x 509
Peso - Weight - Gewicht - Peso	kg	30	39

